

OMEGA

DIE VIELFALT DER MÖGLICHKEITEN

Das Systemprogramm
von KOINOR
Made in Bavaria/Germany

KOINOR

SOFAS
FOR FRIENDS



DIE VIELFALT DER MÖGLICHKEITEN

THE MULTIPLICITY OF POSSIBILITIES

... denn Individualität ist eben keine reine Kopfsache, sondern im Falle eines Sitzmöbels in erster Linie Sache der Form, des Komforts und der Maße. So unterschiedlich die menschliche Ergonomie, das Komfortempfinden, so einzigartig menschliche Wohnsituationen und so verschieden der persönliche Geschmack – so vielfältig ist das Systemprogramm OMEGA.

In Sachen Anpassungsfähigkeit ist OMEGA ein echtes Chamäleon, das sich seinen Besitzern, seiner Umgebung und praktisch allen Anforderungen anpasst, die an es gestellt werden. OMEGA ist die Lösung für alle, die keine Sitzmöbel von der Stange wollen.

... for individuality is not all in the head, but, in the case of seating furniture, is primarily a matter of shape, comfort and dimensions. Human living environments are as unique as human ergonomics and senses of comfort are different, and the modular range OMEGA is as varied as personal tastes are diverse. In terms of its adaptability, OMEGA is a real chameleon which adapts to its owners, its environments and practically all the requirements that are made of it. OMEGA is the solution for anyone who does not want off-the-peg seating furniture.





OMEGA

1. Individualität und Persönlichkeit zeigt zum Beispiel das asymmetrische Einzelsofa.

2. Der aufwändige Leiterstich als Alternative zur Standardnaht kann Ton in Ton oder in Kontrastfarbe gefertigt werden.

3. Besonderer Sitzkomfort: Sie haben die Wahl zwischen verschiedenen Polsteraufbauten – Federkern, Komfortsoft oder Boxspring – sowie unterschiedlichen Sitzhöhen und -tiefen.

4. Nachhaltig in der Form und bodennah oder bodenfrei auf Füßen: Jeweils sechs unterschiedliche Seitenteile vereinen individuellen Komfort und ausdrucksstarke Optik.

5. Auch raffiniertes und sinnvolles Zubehör gehört zu einem guten System: wie die integrierte Leseleuchte oder eine frei positionierbare Kopfstütze.

6. Die optimale Kombination aus Sitz-, Liege- und Eckelementen macht aus Ihrem Wohnzimmer eine Erlebnislandschaft.

1. The asymmetrical single sofa, for example, shows individuality and personality.

2. Elaborate square seam stitching as an alternative to standard stitching can be done tone on tone or in contrasting colour.

3. Particular sitting comfort: you have the choice between a variety of upholstery structures – spring core, comfort soft or boxspring – as well as different seat heights and depths.

4. With a lasting shape and ground-based or off the floor on feet: six different side parts of each type combine individual comfort and an expressive appearance.

5. A good system also includes refined and useful accessories: such as the integrated reading light or a headrest that can be positioned as you desire.

6. The optimum combination of seating, reclining and corner elements make your living room into a landscape of experience.

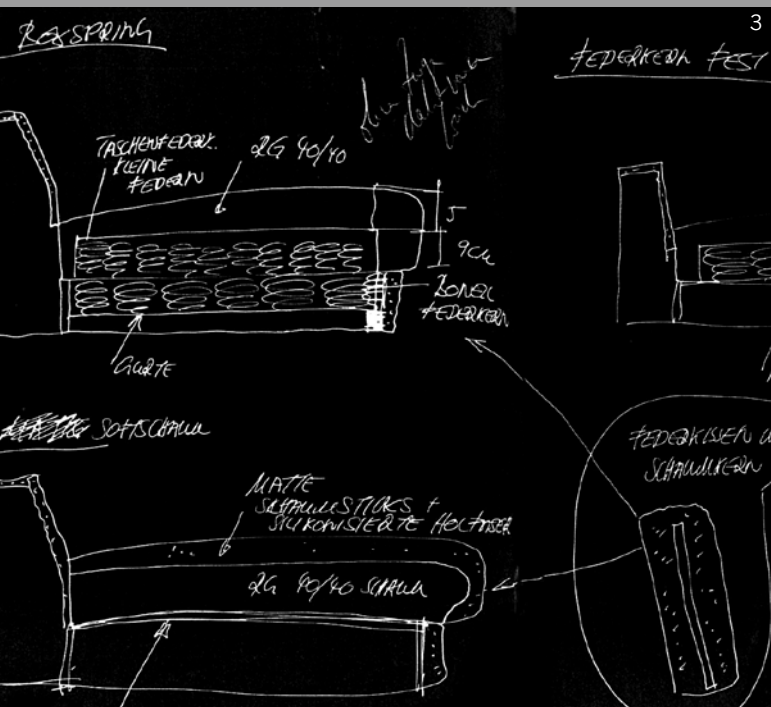



In Sachen Komfort ist das anpassungsfähige Systemmöbel eine Klasse für sich. OMEGA überzeugt aber auch durch seine Programmtiefe und -vielfalt. Mit 5 unterschiedlichen Sitzbreiten und insgesamt 96 Einzeltypen finden Sie ganz einfach die Zusammenstellung, die zu Ihnen passt. Sollten trotz der umfangreichen Möglichkeiten, die OMEGA bietet, Kundenwünsche offen bleiben, fragen Sie uns! Vieles ist als Sonderanfertigung denkbar.

When it comes to comfort, this adaptable modular furniture is in a class of its own. However, OMEGA is also impressive in terms of product range extent and diversity. Five different seat depths and a total of 96 different designs are on offer. Simply find the version that is right for you. Should OMEGA fail to meet a customer requirement despite this extensive range of options, just ask us! Numerous features may be possible by way of a customised version.



ARM 6



ARM 5



ARM 14





OMEGA



Ob oben oder unten – immer eine Augenweide! Alternativ zu den verschiedenen feststehenden Armlehnen gibt es auch die individuell verstellbaren Flexarmteile 6 und 16, die sich jedem Sitz- und Liegebedürfnis anpassen. Durch feine Rasterbeschläge verstellbar, laden die Armlehnen heruntergeklappt als Kopfstütze zum entspannt relaxten Liegen ein. Außerdem wird so die softkubische Form gelockert, das Sofa erhält eine extra Portion Gemütlichkeit.

Top or bottom – always a looker! As an alternative to the various free-standing armrest versions, there are also the individually adjustable flexible armrests 6 and 16 which adapt to any desired sitting or reclining position. The armrests can be adjusted by means of catch mechanisms and serve as a headrest when fully lowered to allow you to lie down and relax. This also visually breaks the soft cuboid shape and makes the sofa look particularly cosy.



ARM 6





ARM 2



ARM 4



ARM 6



ARM 15



ARM 5



ARM 3



ARM 1



ARM 12

Finden Sie das OMEGA-Sofa, das zu Ihnen passt. Eine ganz entscheidende Rolle spielt dabei das Seitenteil. Armlehnen und Füße von OMEGA sind nicht nur stilprägend, sondern gleichermaßen ergonomiebestimmend, denn mit ihnen variiert die Sitzhöhe. Wählen Sie aus insgesamt 12 Armlehnen und 5 Fußformen! Verleihen Sie Ihrem Sofa mit einem bodennahen Armteil eine zeitlose Eleganz. Oder entscheiden Sie sich, mit einem bodenfreien Seitenteil, für filigrane Leichtigkeit. Bei OMEGA bleiben keine Wünsche offen.

Find the OMEGA sofa that's right for you. In this respect, the side elements play a key role. OMEGA's armrests and feet are not only style defining features but equally important for the sofa's ergonomics, as they determine the seat height. Choose from a total of 12 armrest and 5 feet types! Add timeless elegance to your sofa with side elements that reach almost all the way to the floor. Or go for graceful lightness with side elements that clear the floor. OMEGA simply leaves nothing to be desired.





OMEGA



Sitztiefe/Depth 54/57 cm



In allen Details des Systems offenbaren sich Perfektion und Persönlichkeit. Mit dem gewählten Seitenteil variiert die Sitzhöhe. Auf die Körpergröße abgestimmt werden kann ebenfalls die Sitztiefe. Und auch mit verschiedenen Sitzqualitäten passt sich OMEGA den jeweiligen Komfortpräferenzen an: Sitzen Sie klassisch fest mit Federkern, besonders ergonomisch mit Boxspring oder leger und supersoftig mit Komfortsoft. Diese Variabilität macht OMEGA zum perfekten, individuell angepassten Sitzmöbelprogramm.

All system details reflect perfection and personality. The seat height varies depending on the side elements chosen. The seat depth can also be adapted to suit the size of the sofa's users. And OMEGA also adapts to the respectively preferred comfort level with different seat types: firm traditional pocket sprung, particularly ergonomic boxspring or relaxed and super-squishy soft comfort seats. OMEGA's variability makes it the perfect individually customisable seating range.

OMEGA



ARM 1



ARM 12



ARM 15





Wenn die Form der Funktion folgt, ohne ihr Äußeres davon bestimmen zu lassen, dann ist das richtig gutes Design. Beim OMEGA-Systemprogramm ist das in idealer Weise gelungen. Anders als bei Einzelmöbeln müssen in einem System nicht nur die einzelnen Polster Elemente zueinander harmonisch in Einklang stehen, sondern auch deren einzelne Bestandteile müssen perfekt aufeinander abgestimmt sein. Da muss optisch und technisch alles passen. Bei OMEGA können Sie frei aus allen Elementen wählen und sie nach Herzenslust kombinieren, denn der konsequente Designcode sorgt dafür, dass das letztendliche Erscheinungsbild immer perfekt ist.

If form follows function, without the external appearance being determined by this, then that is a really good design. In the OMEGA modular range, this has been achieved perfectly. Unlike for individual pieces of furniture, not only do the individual upholstered elements in a system have to be in harmony, but their individual components must be perfectly coordinated to one another. Everything must go together visually and technically. With OMEGA, you can freely choose from amongst all the elements and combine them to your heart's desire, for the consistent design code ensures that the final appearance is always perfect.















Bei aller Aufmerksamkeit gegenüber sichtbaren Qualitäten wie Design, Oberfläche und Formenvielfalt sind es auch die kleinen, kaum sichtbaren Extras, mit denen sich OMEGA von der Masse abhebt und auch im letzten Quäntchen individuell auf Ihre Bedürfnisse abstimmen lässt. Ob das die ergonomischen Kopfstützen sind, wahlweise mit oder ohne Funktion, die passenden Dekokissen, das integrierte Schubfach oder die Leseleuchte – OMEGA passt sich Ihrem Leben an und nicht umgekehrt.

Regardless of all the immediately obvious characteristics such as the overall design, the choice of covers and the range of different shapes, it is also the small, hardly visible extras that make OMEGA stand out from the crowd and ensure that it is customisable down to the minutest details. Whether these are ergonomic adjustable or fixed headrests, matching scatter cushions, an integrated drawer or a reading light – OMEGA adapts to your lifestyle, rather than vice versa.



OME



Die Vielfalt der Möglichkeiten ...

Ein kompaktes Einzelsofa für kleine Räume? Oder doch lieber die große legere Sitzlandschaft? Mit oder ohne Sessel? Und vielleicht noch einen Hocker dazu? Die Vielzahl an Varianten ist schier unendlich ... damit OMEGA ganz sicher zu Ihnen und Ihrem Zuhause passt.

A multitude of possibilities...

A compact single sofa for small rooms? Or maybe the generously-sized modular version after all? With or without matching armchairs? And maybe a matching stool, too? The multitude of versions is sheer limitless ... to make sure that OMEGA is definitely right for you and your home.

GA



IHR OMEGA KONFIGURATOR

YOUR OMEGA CONFIGURATOR

Wer die Wahl hat ...
Um Ihnen die individuelle
Zusammenstellung Ihres
OMEGA-Systemmöbels zu
erleichtern, hier eine
Übersicht der Optionen.

Spoilt for choice ...
To make the individual
composition of your OMEGA
modular furniture easier for
you, here is an overview of
the options.

5 Sitzbreiten

In Zehn-Zenti-
meter-Schritten
werden die Sitz-
kissen breiter:
60, 70, 80, 90
oder 100 cm.
Dazu noch die
elegante, extra-
breite Liege mit
Sitzkissen in
120 cm Breite.
OMEGA passt
wirklich jedem.

5 seat widths

The seat cush-
ions get wider
in increments of
ten centime-
tres: 60, 70, 80,
90 or 100 cm.
There is also the
elegant lounge
with an outsize
seat cushion
120 cm wide.
OMEGA really
suits anyone.

2 Sitztiefen

54 oder 57 cm

3 cm Unter-
schied, das
klingt nicht nach
viel, hat aber
große Auswirkun-
gen auf den Sitz-
komfort.

2 seat depths

54 or 57 cm

3 cm differ-
ence, that
doesn't sound
like much, but
has a major im-
pact on sitting
comfort.

6 Seitenteile

bodenfrei

Optik und Kom-
fort zugleich:
Wählen Sie aus
4 kubischen und
einem konischen
Seitenteil sowie
einer Flexarm-
lehne.

6 side parts

off the floor

Visual appear-
ance and com-
fort at the same
time: choose
from 4 cubic and
one conical side
part and an ad-
justable armrest.

2 Sitzhöhen

43 oder 46 cm

Entspannt sitzen
lässt sich nur auf
gut angepassten
Sitzmöbeln. Am
besten, Sie prob-
ieren den Unter-
schied direkt
einmal aus ...

2 seat heights

43 or 46 cm

You can only
relax on well-
adjusted seating
furniture.
Ideally, you
should try the
difference out
directly ...

5 Füße

Ein eleganter
Winkelfuß, ein
klassischer
Rundrohrfuß,
eine Kufe sowie
ein Holz- und ein
Metallfuß stehen
in verschiedenen
Oberflächen
zur Auswahl.

5 types of feet

The choice of
feet consists of
elegant angled
feet, classic
tubular feet,
runners as well
as wooden and
metal feet in
various finishes.

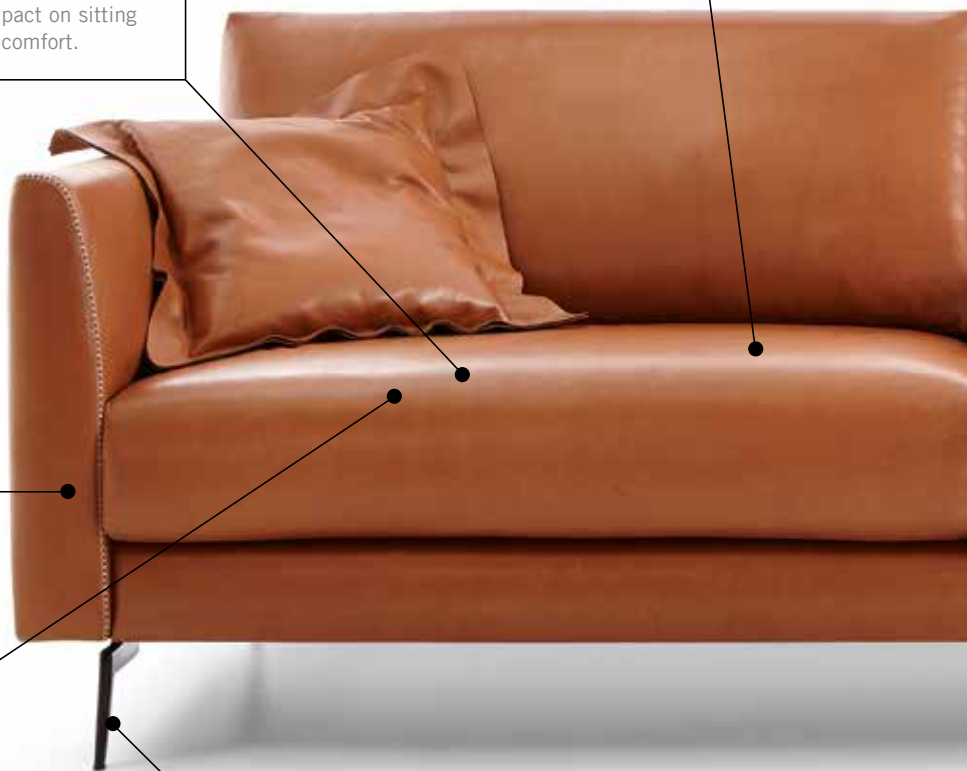

WÄHLEN SIE GRUNDELEMENTE UND ERWEITERUNGEN, AUSGEHEND VON DER GEWÜNSCHTEN SITZBREITE

CHOOSE BASIC ELEMENTS AND EXTENSIONS, STARTING WITH THE DESIRED SEAT WIDTH

WÄHLEN SIE AUS 5 SITZBREITEN
PLUS 120 CM

CHOOSE FROM 5 SEAT WIDTHS
PLUS 120 CM

SESSEL
ARMCHAIRS



EINZELSOFAS
SINGLE SOFAS



EINZELSOFAS ASYMMETRISCH
MIT BLOCKABSCHLUSS
ARMLEHNE LINKS ODER RECHTS
SINGLE SOFAS, ASYMMETRICAL WITH
BLOCK ENDING, ARMREST LEFT OR RIGHT



60 cm



BW 60



BW 120

70 cm

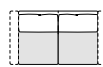

BW 140

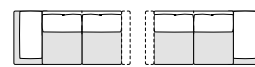

BW 190

80 cm



BW 160



BW 210

90 cm

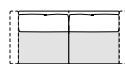

BW 180



BW 230

100 cm



BW 200



BW 250

**ANBAUELEMENTE MIT ARMLEHNE
LINKS ODER RECHTS**
ADD-ON ELEMENTS WITH ARMREST
LEFT OR RIGHT



**ANBAUELEMENTE MIT SCHUBFACH
ARMLEHNE LINKS ODER RECHTS**
ADD-ON ELEMENTS WITH A DRAWER
ARMREST LEFT OR RIGHT



**ANBAUELEMENTE MIT HÖCKER-
ABSCHLUSS LINKS ODER RECHTS**
ADD-ON ELEMENTS WITH
STOOL ENDING LEFT OR RIGHT

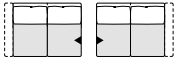

BW 120

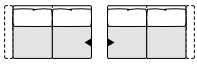

BW 140

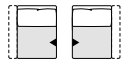

BW 70

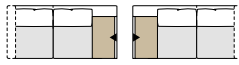

BW 185

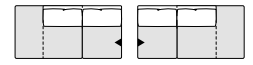

BW 190

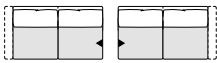

BW 160

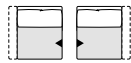

BW 80

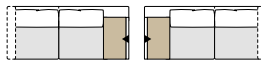

BW 205

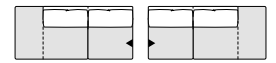

BW 210

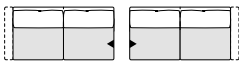

BW 180

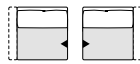

BW 90

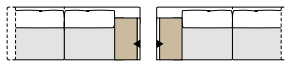

BW 225

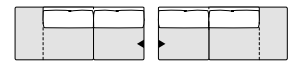

BW 230

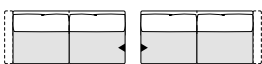

BW 200

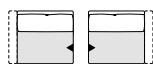

BW 100

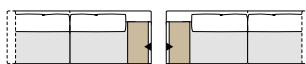

BW 245



BW 250

Alle Maße sind Zirkumaße in Zentimeter. Armteile sind exemplarisch mit 15 cm Breite dargestellt. Die Kombination von zwei Anbauelementen nebeneinander ist konstruktiv bedingt nicht möglich. Sie können angebaut werden an Zwischenelemente, Liegen, Anbauecken, Eckteile. Zur Planung verwenden Sie auch den beiliegenden Planungsbogen.

ANBAUELEMENTE MIT BLOCKABSCHLUSS LINKS ODER RECHTS
ADD-ON ELEMENTS WITH BLOCK ENDING LEFT OR RIGHT



ZWISCHENELEMENTE OHNE ARMLEHNE
MIDDLE ELEMENTS WITHOUT ARMREST



LIEGEN MIT ARMLEHNE LINKS ODER RECHTS
RECLINERS WITH ARMREST LEFT OR RIGHT



Seitenansicht
side view

Sitzbreite
Seat width

120 cm

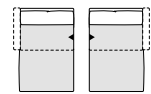

BW 120 TD 187

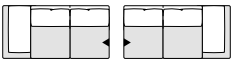

BW 190

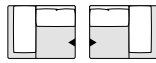

BW 120



BW 140



BW 210



BW 130



BW 160



BW 240

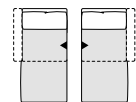

BW 80 TD 167



BW 230



BW 140

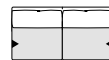

BW 180

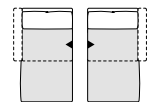

BW 90 TD 167

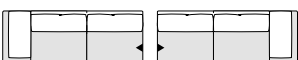

BW 250



BW 150

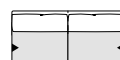

BW 200

Mit Wunscharmlehne jeweils 6 Versionen bodennah und bodenfrei.
 Alle Breitenmaße sind angegeben ohne die Breite der jeweiligen Armlehne.
 Bitte addieren Sie daher für die **ARMLEHNEN 1** und **11** jeweils 12 cm,
 für die **ARMLEHNEN 2, 12, 4** und **14** jeweils 15 cm, für die **ARMLEHNEN**
3, 13, 5 und **15** jeweils 25 cm, für die **FLEXARMLEHNEN 6** und **16**
 jeweils min. 16 cm.

There are 6 off-the-floor and 6 ground-based versions for your **chosen armrest**. All the widths are given minus the width of the respective armrest. Therefore, please add 12 cm for **ARMRESTS 1** and **11**; 15 cm for **ARMRESTS 2, 12, 4** and **14**; 25 cm for **ARMRESTS 3, 13, 5** and **15**; 16 cm for the **ADJUSTABLE ARMRESTS 6** and **16**.

ECKELEMENT
CORNER ELEMENT



ANBAUECKEN MIT HOCKER-ABSCHLUSS LINKS ODER RECHTS
ADD-ON CORNERS WITH STOOL ENDING LEFT OR RIGHT



Seitenansicht
 side view

ANBAUECKEN MIT BLOCK-ABSCHLUSS LINKS ODER RECHTS
ADD-ON CORNERS WITH BLOCK ENDING LEFT OR RIGHT



Seitenansicht
 side view

HOCKER STOOLS

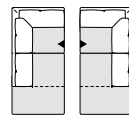

BW 192

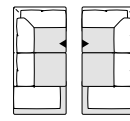

BW 192

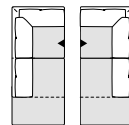

BW 212

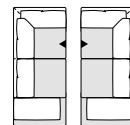

BW 212

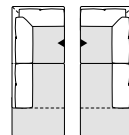

BW 232

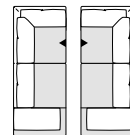

BW 232



BW 80 TD 60



BW 160 TD 60

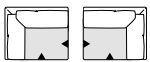

BW 113

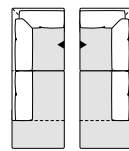

BW 252

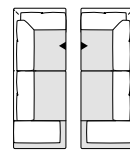

BW 252



BW 90 TD 90

Bezugsvielfalt

Wählen Sie aus insgesamt mehr als 400 verschiedenen Farben in den unterschiedlichsten Qualitäten – sei es Leder, Stoff oder Mikrofaser.



Variety of coverings

Choose from a total of more than 400 different colours in different materials – including leather, fabric or microfibre.

2 Nahtvarianten

Standardnaht oder effektvoller Zierstich als traditionelles, handwerkliches Detail und Zeichen besonderer Produktqualität: jeweils Ton in Ton oder in einer von 8 attraktiven Kontrastfadenfarben für Sie gefertigt.

2 stitching options

Standard stitching or impressive decorative stitching are proof of the outstanding quality and traditional craftsmanship, each either done tone on tone or in one of 8 attractive contrasting thread colours.

6 Seitenteile bodennah

Wie die bodenfreien Pendants tragen auch sie entscheidend zum Look des Sitzmöbels bei – bodennah wirken sie eher zeitlos-klassisch, bodenfrei dagegen filigran-leicht.

6 side parts ground-based

Like their off-the-floor counterparts, they make a decisive contribution to the look of the seating furniture – here timeless and classical, but delicate and light-weight off-the-floor.

3 Sitzqualitäten

Klassisch mit Federkern, leger und supersoftig oder elastisch mit Boxspring-Federung, die Sie vielleicht aus Hotelbetten kennen.

3 seat qualities

Traditional with a spring core, casual and super soft or elastic with boxspring suspension, which you may be familiar with from high-quality hotel beds.

Zubehör

Mit praktischer Kopfstütze, verschiedenen Dekokissen, einer Leseleuchte oder dem integrierten Schubfach wird OMEGA sogar noch komfortabler (nicht im Bild).

Accessories

With a practical headrest, several sofa cushions, a reading light or the integrated drawer, OMEGA becomes even more comfortable (not illustrated).

BODENFREI ODER BODENNAH – WÄHLEN SIE DIE ARMLEHNE

ALLE PREISGLEICH

OFF THE FLOOR OR GROUND-BASED – CHOOSE THE ARMREST

ALL IDENTICAL IN PRICE

ARMLEHNE BODENFREI ARMREST OFF THE FLOOR



ARMLEHNE 1
ARMREST 1
konisch
conical



65

BW 12

ARMLEHNE 2
ARMREST 2
hoch/schmal
high/small



65

BW 15

ARMLEHNE 3
ARMREST 3
hoch/breit
high/wide



65

BW 25

ARMLEHNE 4
ARMREST 4
niedrig/schmal
low/small



55

BW 15

ARMLEHNE 5
ARMREST 5
niedrig/breit
low/wide



55

BW 25

ARMLEHNE 6
ARMREST 6
flexibel
flexible



min. 55
max. 65

BW min. 16 / max. 27

ARMLEHNE BODENNAH ARMREST GROUND-BASED



ARMLEHNE 11
ARMREST 11
konisch
conical



65

BW 12

ARMLEHNE 12
ARMREST 12
hoch/schmal
high/small



65

BW 15

ARMLEHNE 13
ARMREST 13
hoch/breit
high/wide



65

BW 25

ARMLEHNE 14
ARMREST 14
niedrig/schmal
low/small



55

BW 15

ARMLEHNE 15
ARMREST 15
niedrig/breit
low/wide



55

BW 25

ARMLEHNE 16
ARMREST 16
flexibel
flexible



min. 55
max. 65

BW min. 16 / max. 27

WÄHLEN SIE AUS 5 FUSSFORMEN FÜR BODENFREIE ARMLEHNEN UND ELEMENTE

ALLE PREISGLEICH

YOUR OMEGA CONFIGURATOR

CHOOSE FROM 5 LEG SHAPES FOR ALL ARMRESTS AND ELEMENTS OFF THE FLOOR

ALL IDENTICAL IN PRICE

**FUSS 1:
GRAZILER WINKELFUSS
FOOT 1:
DELICATE ANGLED FOOT**

in 4 Ausführungen:
Metall pulverbeschichtet hochglanz-schwarz, Metall bronze lackiert, Aluminium matt (satinert), Aluminium glänzend (poliert)
in 4 versions:
metal powder-coated in high-gloss black, shiny metal painted bronze, matt aluminium (satined), aluminium shiny (polished)

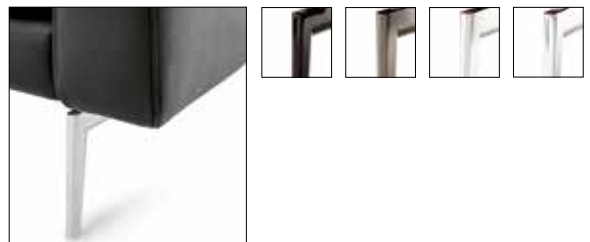

**FUSS 2:
RUNDROHRFUSS
FOOT 2:
ROUND TUBULAR FOOT**

in 4 Ausführungen:
Metall schwarz matt lackiert, Metall bronze lackiert, Aluminium matt (satinert), Aluminium glänzend (poliert)
in 4 versions:
metal black matt lacquered, shiny metal painted bronze, matt aluminium (satined), aluminium shiny (polished)

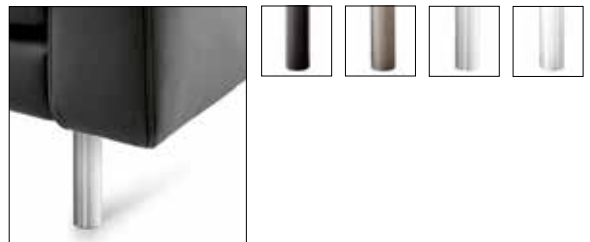

**FUSS 3:
KUFE IN ELLIPSENFORM
FOOT 3:
RUNNER WITH AN
ELLIPTICAL SHAPE**

in 3 Ausführungen:
Metall pulverbeschichtet hochglanz-schwarz, Metall chromglänzend, Metall nickel satinert (Edelstahloptik)
in 3 versions:
metal powder-coated in high-gloss black, shiny chrome metal, satin nickel metal (stainless steel appearance)



**FUSS 5:
HOLZFUSS MASSIV
FOOT 5:
SOLID WOODEN FOOT**

in 4 Ausführungen:
Eiche (geölt), Kernbuche (geölt), Nussbaum (geölt), Buche P11 wenge (lackiert)
in 4 versions:
oak (oiled), beech heartwood (oiled), walnut (oiled), beech P11 wenge (lacquered)



**FUSS 6:
KOMPAKTER WINKELFUSS
FOOT 6:
COMPACT ANGLED FOOT**

in 1 Ausführung:
Metall nickel satinert (Edelstahloptik)
in 1 version:
satin nickel metal (stainless steel appearance)



IHR OMEGA KONFIGURATOR

IHR OMEGA KONFIGURATOR WÄHLEN SIE SITZHÖHE UND -TIEFE SITZTIEFENPOLSTER OPTIONAL

YOUR OMEGA CONFIGURATOR

YOUR OMEGA CONFIGURATOR CHOOSE SEAT HEIGHT AND DEPTH SEAT DEPTH PAD AS AN OPTION

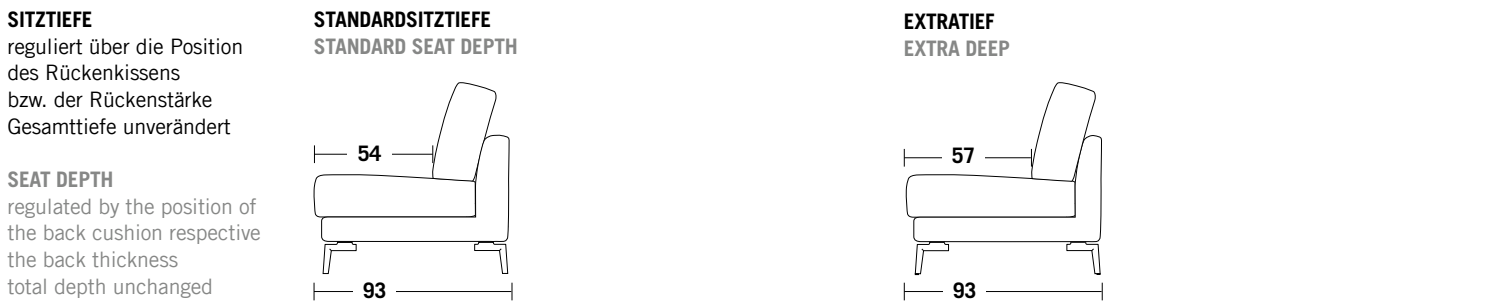
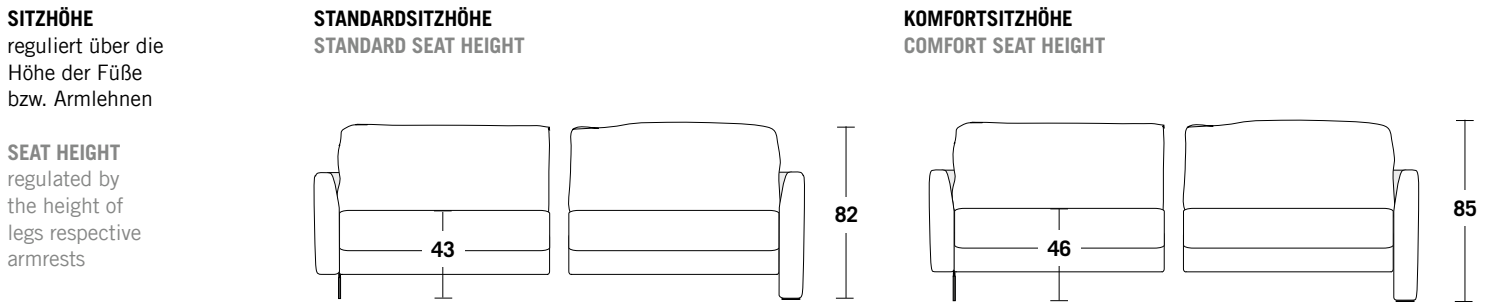

SITZTIEFENPOLSTER
Sitztiefenwechsel damit auch innerhalb eines Sofas möglich
ST 57 cm → ST 54 cm
ST 54 cm → ST 51 cm

SEAT DEPTH PAD
allows seat depth adjustment also within a sofa
SD 57 cm → SD 54 cm
SD 54 cm → SD 51 cm



IHR OMEGA KONFIGURATOR

WÄHLEN SIE DEN KOMFORT: FEDERKERN, KOMFORTSOFT ODER BOXSPRING

YOUR OMEGA CONFIGURATOR

CHOOSE YOUR UPHOLSTERY: SPRING CORE, COMFORT SOFT OR BOXSPRING

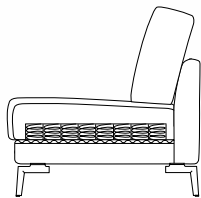

FEDERKERN
SPRING CORE

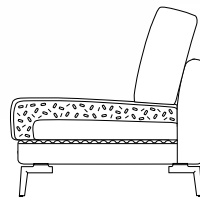

KOMFORTSOFT (gegen Aufpreis)
COMFORT SOFT (against extra charge)

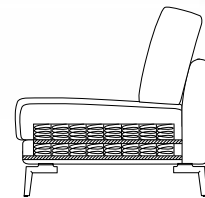

BOXSPRING (gegen Aufpreis)
BOXSPRING (against extra charge)

SITZKISSEN
SEAT CUSHION

festgenäht (Standard) oder
lose (gegen Aufpreis)
fixed (standard) or
loose (against extra charge)

festgenäht (Standard) oder
lose (gegen Aufpreis)
fixed (standard) or
loose (against extra charge)

festgenäht (Standard) oder
lose (gegen Aufpreis)
fixed (standard) or
loose (against extra charge)

RÜCKENKISSEN
BACK CUSHION

lose (Standard)
loose (standard)

lose (Standard)
loose (standard)

lose (Standard)
loose (standard)

POLSTERUNG
UPHOLSTERY

leger/locker
casual/loose

besonders leger
particularly casual

leger/locker
casual/loose

HÄRTEGRAD
LEVEL OF HARDNESS

fest
firm

weich
soft

medium (elastisch)
medium (elastic)

IHR OMEGA KONFIGURATOR
LEDER ODER STOFF?

YOUR OMEGA CONFIGURATOR
LEATHER OR FABRIC?



Der Bezug Ihres Sofas spiegelt Ihren persönlichen Geschmack auf den ersten Blick wider. Außerdem wird er den Anforderungen gerecht, die Sie an uns stellen: Er ist natürlich, robust und pflegeleicht.

Für OMEGA stehen daher insgesamt mehr als 400 verschiedene Farben in unterschiedlichsten Qualitäten zur Wahl. Vor allem unsere Leder zeichnen uns aus. Sie verbinden Ästhetik und Alltagstauglichkeit perfekt. Durch sie werden Polstermöbel zu Persönlichkeiten. Aber auch textile Bezugsmaterialien liegen im Trend. Den Möglichkeiten bei Farben und Mustern sind gerade hier keine Grenzen gesetzt.

The cover of your sofa reflects your personal taste at first glance. It also meets the requirements that you make of us: it is natural, robust and easy to clean.

For OMEGA, there are, in total, more than 400 different colours available for selection with a wide variety of materials. We are particularly known for our leather. It combines aesthetics and suitability for everyday use perfectly. It gives upholstered furniture personalities. But textile cover materials are also in fashion. There are no bounds to the possibilities for colours and patterns here.

NAHTVERARBEITUNG AN ARMTEILEN UND ELEMENTEN MIT BLOCKABSCHLUSS

SEAMS ON ARMRESTS AND ELEMENTS WITH BLOCK ENDING

LEDER: STANDARDNAHT

LEATHER: STANDARD STITCHING



Ton in Ton oder mit Kontrastfaden, Kontrastfadenfarbe frei wählbar
tone on tone or with contrasting thread, thread colour freely selectable

STOFF / MIKROFASER: STANDARDNAHT

FABRIC / MICROFIBRE: STANDARD STITCHING

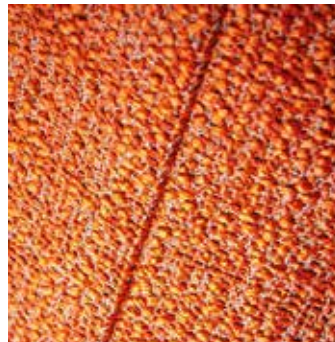

materialbedingt geschlossene Naht bzw. Naht Ton in Ton
closed seam respective thread tone on tone depending on the material

LEDER: ZIERSTICH (GEGEN AUFPREIS)

LEATHER: DECORATIVE STITCHING (AGAINST EXTRA CHARGE)



Ton in Ton oder mit Kontrastfaden, Kontrastfadenfarbe frei wählbar
tone on tone or with contrasting thread, thread colour freely selectable

STOFF / MIKROFASER: ZIERSTICH (GEGEN AUFPREIS)

FABRIC / MICROFIBRE: DECORATIVE STITCHING (AGAINST EXTRA CHARGE)

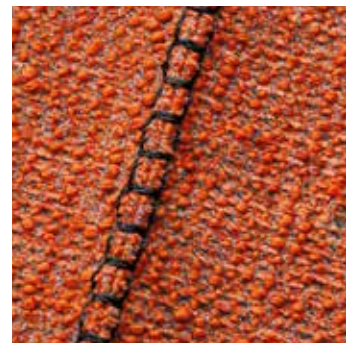

Ton in Ton oder mit Kontrastfaden, Kontrastfadenfarbe frei wählbar
tone on tone or with contrasting thread, thread colour freely selectable

MÖGLICHE KONTRASTFADENFARBEN

POSSIBLE CONTRASTING COLOUR THREADS



0321
hellgrau
light grey



1222
beige
beige



0281
nougat
nougat



0415
grau
grey



1002
dunkelbraun
dark brown



4000
schwarz
black



0504
rot
red



0827
dunkelblau
dark blue

ELEMENTABSCHLÜSSE UND PRODUKTEXTRAS

ELEMENT ENDINGS AND PRODUCT EXTRAS



HOCKERABSCHLUSS

offener Abschluss
geeignet für Flexablagen
immer auf Füßen

STOOL ENDING

with open ending
suitable for flexishelves
always with legs



BLOCKABSCHLUSS

mit Blockkissen (festgenäht)
immer auf Füßen

BLOCK ENDING

with block cushion (fixed)
always with legs



SCHUBFACH

fest integriert
Echtholz furnier: amerik. Nuss-
baum; Eiche in den Farben natur,
P11 (wenge) oder schwarz;
Asteiche natur oder gekalkt

DRAWER

integrated component
genuine wood veneer: American
walnut; oak in the colours natural
oak, P11 (wenge) or black, knob
oak natural or chalked



LED-LESELEUCHE

möglich bei Elementen mit
Schubfach oder Blockabschluss
fest integriert
nachträgliche Montage nicht
möglich

LED READING LIGHT

available with all elements
with drawer or block ending
integrated component
subsequent assembly not possible



KOPFSTÜTZE

einsteckbar und
frei zu positionieren durch
Metallbügel: chromglänzend,
nickel satiniert (Edelstahloptik)
oder pulverbeschichtet hoch-
glanz-schwarz

HEADREST

insertable to be freely positioned
with metal bracket: shiny chrome,
nickel satined (stainless steel
optics) or powder-coated high
gloss black



KOPFSTÜTZE MIT FUNKTION

zusätzlich durch einen
integrierten Rasterbeschlag
in verschiedene Positionen
nach vorn zu verstellen

FUNCTIONAL HEADREST

with additionally integrated
catch mechanism that allows
the adjustment in different
forward positions

